

Lighting

Tracks

LIGHTING TRACKS

TABLE OF CONTENTS

02	Introduction
04	3 circuit track system
05	Recessed 3 circuit track system
06	Connection parts - (Recessed) 3 circuit track system
12	3 circuit DALI track system
13	Recessed 3 circuit DALI track system
14	Connection parts - (Recessed) 3 circuit DALI track system
22	Accessories track system
26	Track system accessories diagram

Edition 20220621.

All prices are gross prices, stated in Euro, without VAT.

Delivery conditions within the Benelux

Net order value < € 250,-	€ 10,- per order
1 + 2 meter length profiles. Net order value > € 250,-	€ 15,- per order (Net order value < € 250,- + € 10,- surcharge)
3 meter length profiles. Net order value > € 250,-	€ 35,- per order (Net order value < € 250,- + € 10,- surcharge)

For deliveries outside of the Benelux, shipping costs are available on request or Ex Works.

(3 meter tracks are not available outside the Benelux.)

Copyright © 2022, ILLUXTRON. All rights reserved.

The information in this document is subject to change without prior notice. Our terms and conditions apply to all our products and services. On request, we can send you a copy of our terms and conditions. Our terms and conditions are also available on our website.

Illuxtron International BV

Mercuriusweg 19
info@illuxtron.com

4382 NC Vlissingen
+31 (0)85 773 63 60

The Netherlands
www.illuxtron.com



LIGHTING TRACKS

Illuxtron offers a high quality 3 circuit (3-phase) lighting track system which is fully compatible with 3-phase adapters of all major brands. The comprehensive range of innovative accessories – like the twisted L and T connectors – gives the designer maximum freedom to create the ultimate track plan. The track can easily be shortened and the Ezklik mounting features make the track system quick and easy to install. After cutting the track it's immediately ready to install and there is no need to adjust the wires.

The track products are being produced under certified ISO9001 and ISO14000 regulations and ENEC, UL, TUV and GS labels which are relevant for the European market.

For more information, please feel free to contact us!



Our sales department is always at your service for any questions or for support.

sales@illuxtron.com
+31 (0)85 773 63 60

Illuxtron International BV

Mercuriusweg 19
4382 NC Vlissingen
The Netherlands

info@illuxtron.com
www.illuxtron.com

3 Circuit track system









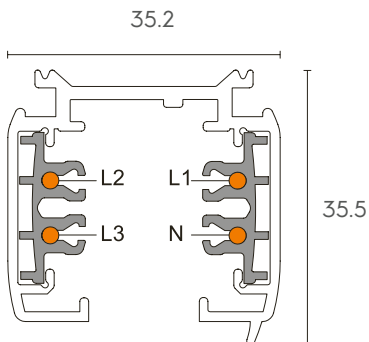

Illuxtron 3-circuit track is a high quality track system for the professional lighting market. The track is suitable for track lights with 3-phase adapters of all major brands. The comprehensive range of innovative accessories - like the twisted L and T connectors - gives the designer maximum freedom to create the ultimate track plan. The track can easily be shortened and the Ezclick mounting features make the track system quick and easy to install. After cutting the track it's immediately ready to install and there is no need to adjust the wires.

3 CIRCUIT TRACK SYSTEM - 04

DIMENSIONS



ITEM SPECIFICATIONS

Product description	Colour	Product Code	Package
1 M track (1000mm)	 White	20EF03MW0002	1 / 6
1 M track (1000mm)	 Grey	20EF03GR0002	1 / 6
1 M track (1000mm)	 Black	20EF03BL0002	1 / 6
2 M track (2000mm)	 White	20EG03MW0002	1 / 6
2 M track (2000mm)	 Grey	20EG03GR0002	1 / 6
2 M track (2000mm)	 Black	20EG03BL0002	1 / 6
3 M track (3000mm)	 White	20EH03MW0002	1 / 6
3 M track (3000mm)	 Grey	20EH03GR0002	1 / 6
3 M track (3000mm)	 Black	20EH03BL0002	1 / 6

Recessed 3 circuit track system







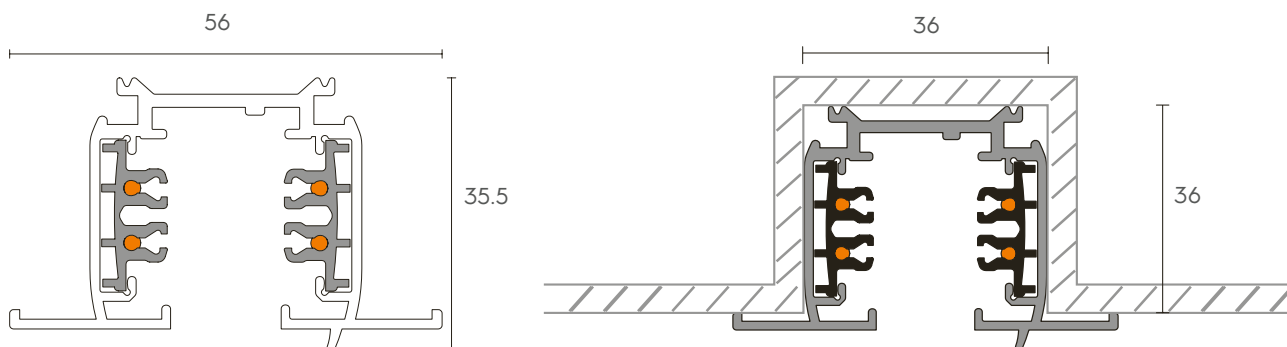



The used accessories for the recessed 3 circuit track are the same as the standard 3 circuit track system and can be covered by special cover accessories (see page 18-21).

DIMENSIONS



ITEM SPECIFICATIONS

Product description	Colour	Product Code	Package
1 M track (1000mm) recessed	 White	20HN03MW0002	1 / 4
1 M track (1000mm) recessed	 Grey	20HN03GR0002	1 / 4
1 M track (1000mm) recessed	 Black	20HN03BL0002	1 / 4
2 M track (2000mm) recessed	 White	20HP03MW0002	1 / 4
2 M track (2000mm) recessed	 Grey	20HP03GR0002	1 / 4
2 M track (2000mm) recessed	 Black	20HP03BL0002	1 / 4
3 M track (3000mm) recessed	 White	20HQ03MW0002	1 / 4
3 M track (3000mm) recessed	 Grey	20HQ03GR0002	1 / 4
3 M track (3000mm) recessed	 Black	20HQ03BL0002	1 / 4

Connection parts

(Recessed) 3 circuit track system



Connector left

ITEM SPECIFICATIONS

Colour	Product Code	Package
<input type="checkbox"/> White	20EJ03MW0002	12 / 144
<input type="checkbox"/> Grey	20EJ03GR0002	12 / 144
<input type="checkbox"/> Black	20EJ03BL0002	12 / 144

DIMENSIONS

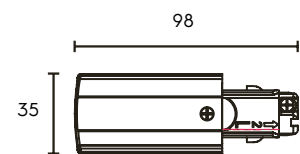

Connector right

ITEM SPECIFICATIONS

Colour	Product Code	Package
<input type="checkbox"/> White	20EK03MW0002	12 / 144
<input type="checkbox"/> Grey	20EK03GR0002	12 / 144
<input type="checkbox"/> Black	20EK03BL0002	12 / 144

DIMENSIONS

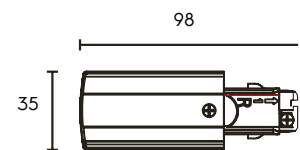

End cap

ITEM SPECIFICATIONS

Colour	Product Code	Package
<input type="checkbox"/> White	20EL03MW0002	15 / 300
<input type="checkbox"/> Grey	20EL03GR0002	15 / 300
<input type="checkbox"/> Black	20EL03BL0002	15 / 300

DIMENSIONS

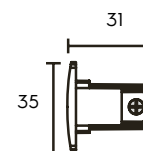

Coupler

ITEM SPECIFICATIONS

Colour	Product Code	Package
<input type="checkbox"/> White	20EM03MW0002	10 / 200
<input type="checkbox"/> Grey	20EM03GR0002	10 / 200
<input type="checkbox"/> Black	20EM03BL0002	10 / 200

DIMENSIONS

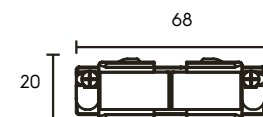



Coupler (insulation)

ITEM SPECIFICATIONS

Colour	Product Code	Package
White	20EN03MW0002	9 / 180
Grey	20EN03GR0002	9 / 180
Black	20EN03BL0002	9 / 180

DIMENSIONS

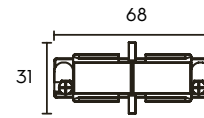

Middle connector

ITEM SPECIFICATIONS

Colour	Product Code	Package
White	20EP03MW0002	10 / 120
Grey	20EP03GR0002	10 / 120
Black	20EP03BL0002	10 / 120

DIMENSIONS

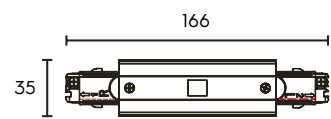

L connector left

ITEM SPECIFICATIONS

Colour	Product Code	Package
White	20EQ03MW0002	18 / 108
Grey	20EQ03GR0002	18 / 108
Black	20EQ03BL0002	18 / 108

DIMENSIONS

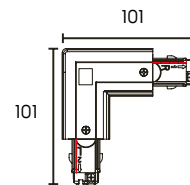

L connector right

ITEM SPECIFICATIONS

Colour	Product Code	Package
White	20ER03MW0002	18 / 108
Grey	20ER03GR0002	18 / 108
Black	20ER03BL0002	18 / 108

DIMENSIONS

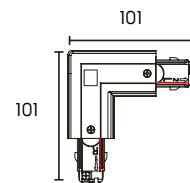

X connector

ITEM SPECIFICATIONS

Colour	Product Code	Package
White	20EW03MW0002	5 / 60
Grey	20EW03GR0002	5 / 60
Black	20EW03BL0002	5 / 60

DIMENSIONS

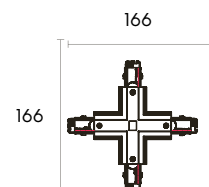



T connector left 1

ITEM SPECIFICATIONS

Colour	Product Code	Package
<input type="checkbox"/> White	20ES03MW0002	12 / 72
<input type="checkbox"/> Grey	20ES03GR0002	12 / 72
<input type="checkbox"/> Black	20ES03BL0002	12 / 72

DIMENSIONS

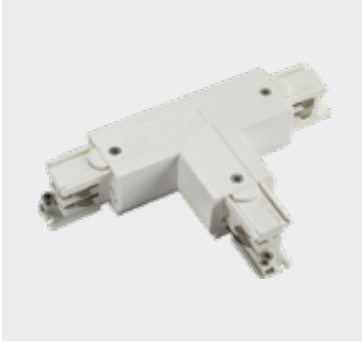
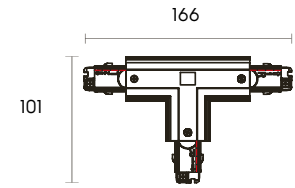

T connector left 2

ITEM SPECIFICATIONS

Colour	Product Code	Package
<input type="checkbox"/> White	20ET03MW0002	12 / 72
<input type="checkbox"/> Grey	20ET03GR0002	12 / 72
<input type="checkbox"/> Black	20ET03BL0002	12 / 72

DIMENSIONS

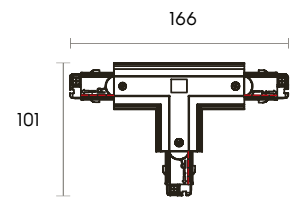

T connector right 1

ITEM SPECIFICATIONS

Colour	Product Code	Package
<input type="checkbox"/> White	20EU03MW0002	12 / 72
<input type="checkbox"/> Grey	20EU03GR0002	12 / 72
<input type="checkbox"/> Black	20EU03BL0002	12 / 72

DIMENSIONS

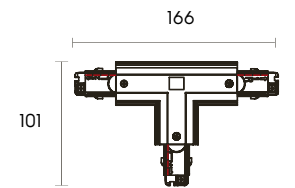

T connector right 2

ITEM SPECIFICATIONS

Colour	Product Code	Package
<input type="checkbox"/> White	20EV03MW0002	12 / 72
<input type="checkbox"/> Grey	20EV03GR0002	12 / 72
<input type="checkbox"/> Black	20EV03BL0002	12 / 72

DIMENSIONS

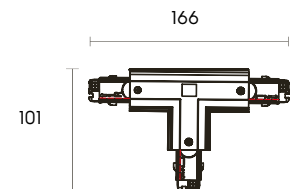

Flexible connector

ITEM SPECIFICATIONS

Colour	Product Code	Package
<input type="checkbox"/> White	20EX03MW0002	14 / 70
<input type="checkbox"/> Grey	20EX03GR0002	14 / 70
<input type="checkbox"/> Black	20EX03BL0002	14 / 70

DIMENSIONS

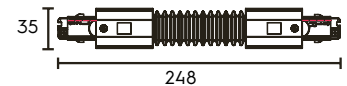



Adjustable connector

ITEM SPECIFICATIONS

Colour	Product Code	Package
White	20EY03MW0002	15 / 90
Grey	20EY03GR0002	15 / 90
Black	20EY03BL0002	15 / 90

DIMENSIONS

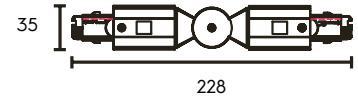

Twisted L connector (L and R)

ITEM SPECIFICATIONS

Colour	Product Code	Package
White	20HB03MW0002	18 / 108
Grey	20HB03GR0002	18 / 108
Black	20HB03BL0002	18 / 108

DIMENSIONS

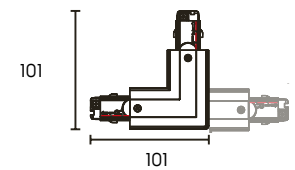

Twisted T connector L1 → L2

ITEM SPECIFICATIONS

Colour	Product Code	Package
White	20HC03MW0002	12 / 72
Grey	20HC03GR0002	12 / 72
Black	20HC03BL0002	12 / 72

DIMENSIONS

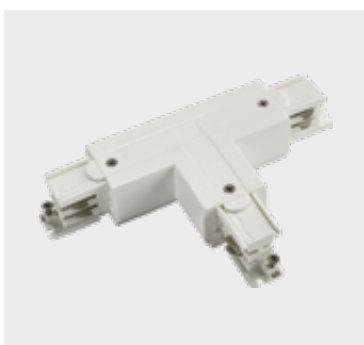
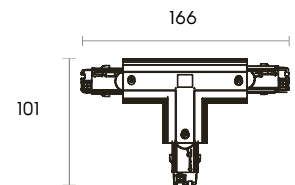

Twisted T connector R1 → R2

ITEM SPECIFICATIONS

Colour	Product Code	Package
White	20HD03MW0002	12 / 72
Grey	20HD03GR0002	12 / 72
Black	20HD03BL0002	12 / 72

DIMENSIONS

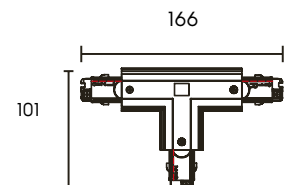

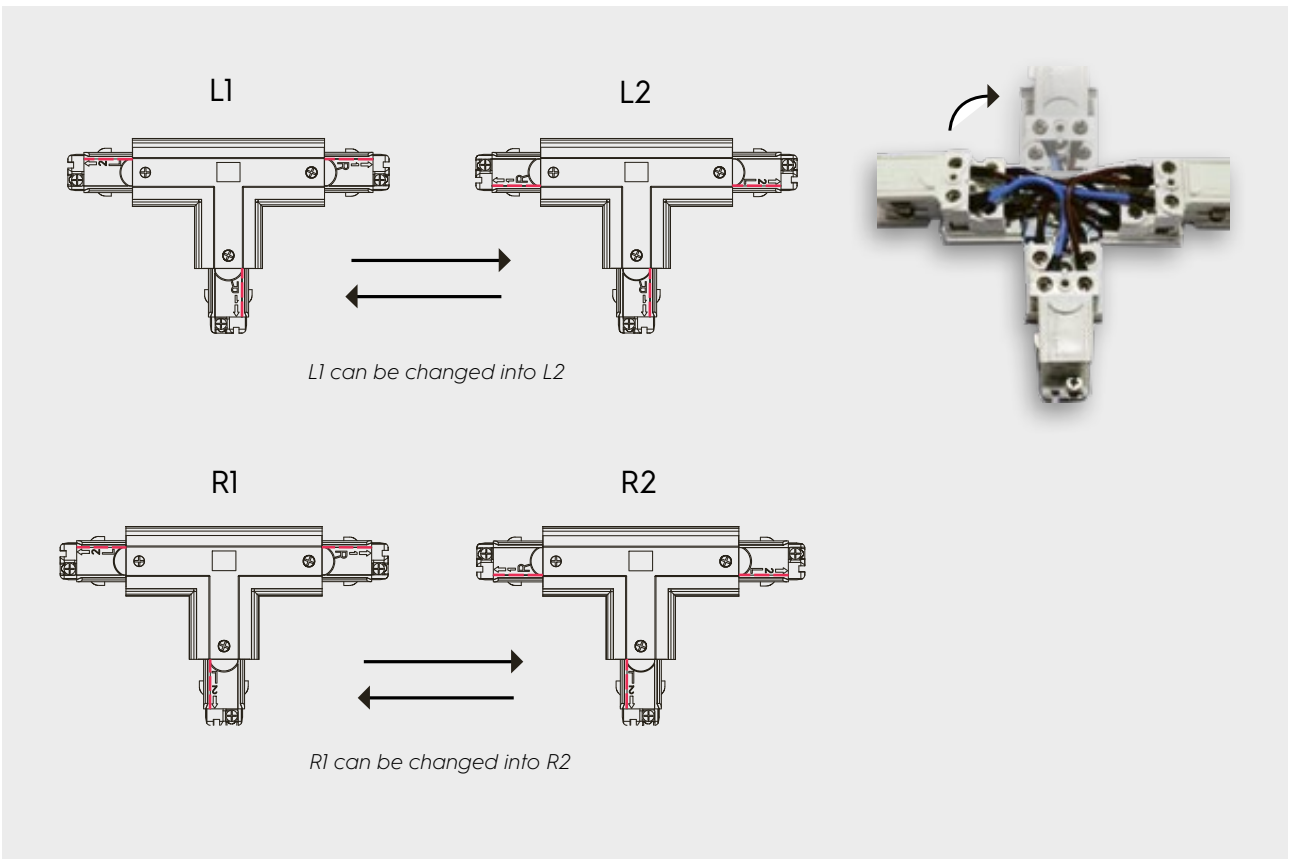

Connecting diagram

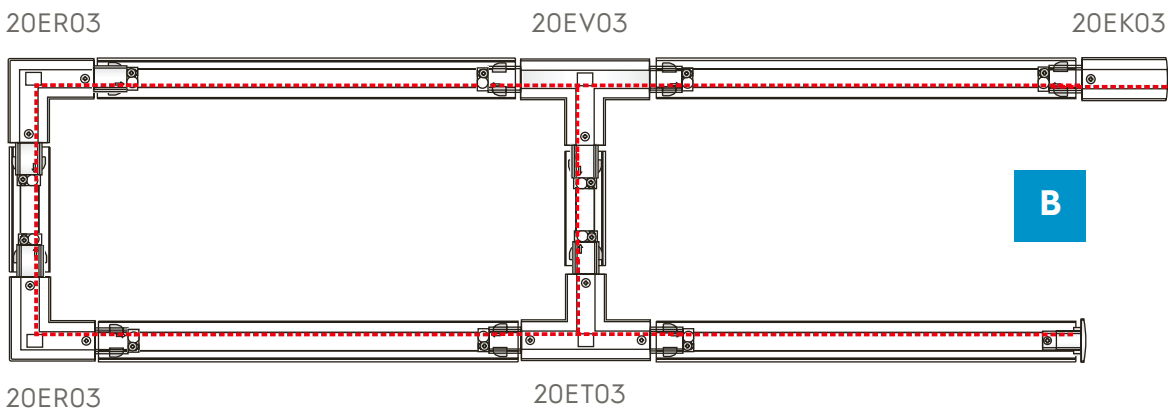
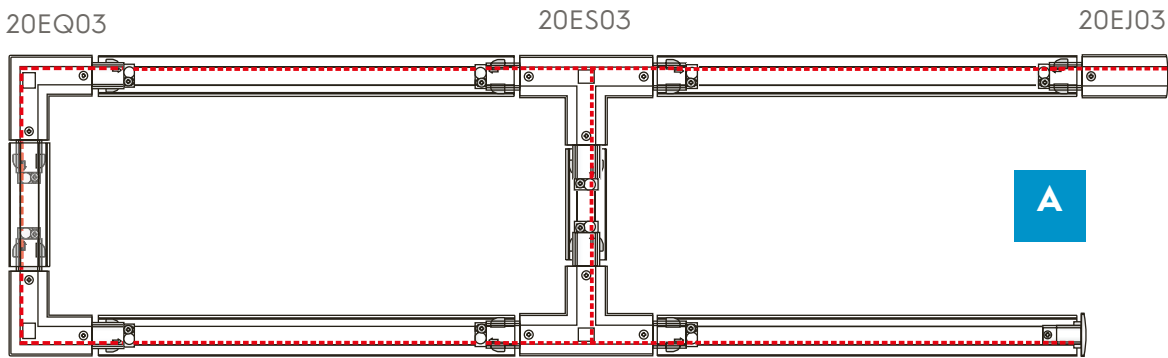



3 Circuit DALI track system



Illuxtron 3 circuit DALI track is a high quality track system for the professional lighting market. Make your lighting track a smart system. The track is suitable for track lights with a 3 circuit DALI adapter. The comprehensive range of innovative DALI accessories gives the designer maximum freedom to create the ultimate track plan. The track can easily be shortened and the Ezklik mounting features make the track system quick and easy to install. After cutting the track it's immediately ready to install and there is no need to adjust the wires.

DIMENSIONS

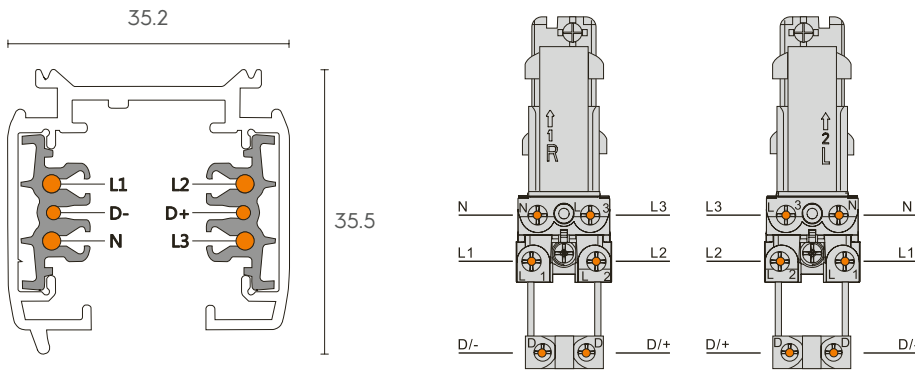

ITEM SPECIFICATIONS

Product description	Colour	Product Code	Package
1 M DALI track (1000mm)	White	20JA03MW0002	1 / 6
1 M DALI track (1000mm)	Grey	20JA03GR0002	1 / 6
1 M DALI track (1000mm)	Black	20JA03BL0002	1 / 6
2 M DALI track (2000mm)	White	20JB03MW0002	1 / 6
2 M DALI track (2000mm)	Grey	20JB03GR0002	1 / 6
2 M DALI track (2000mm)	Black	20JB03BL0002	1 / 6
3 M DALI track (3000mm)	White	20JC03MW0002	1 / 6
3 M DALI track (3000mm)	Grey	20JC03GR0002	1 / 6
3 M DALI track (3000mm)	Black	20JC03BL0002	1 / 6

Recessed 3 circuit DALI track system

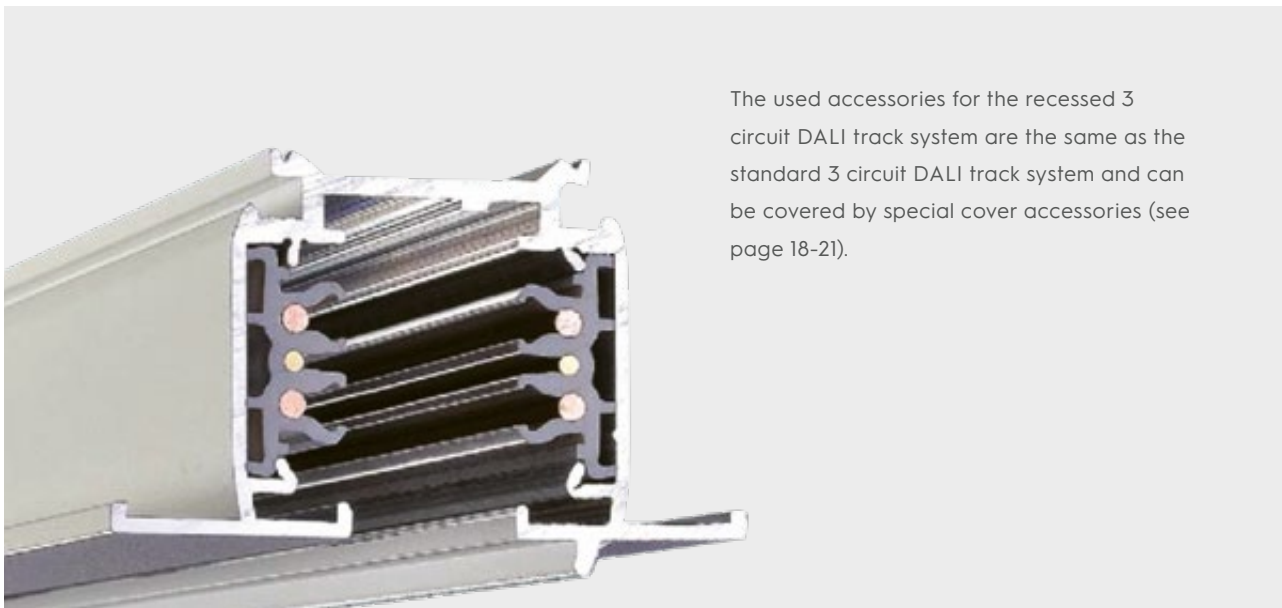

The used accessories for the recessed 3 circuit DALI track system are the same as the standard 3 circuit DALI track system and can be covered by special cover accessories (see page 18-21).

DIMENSIONS

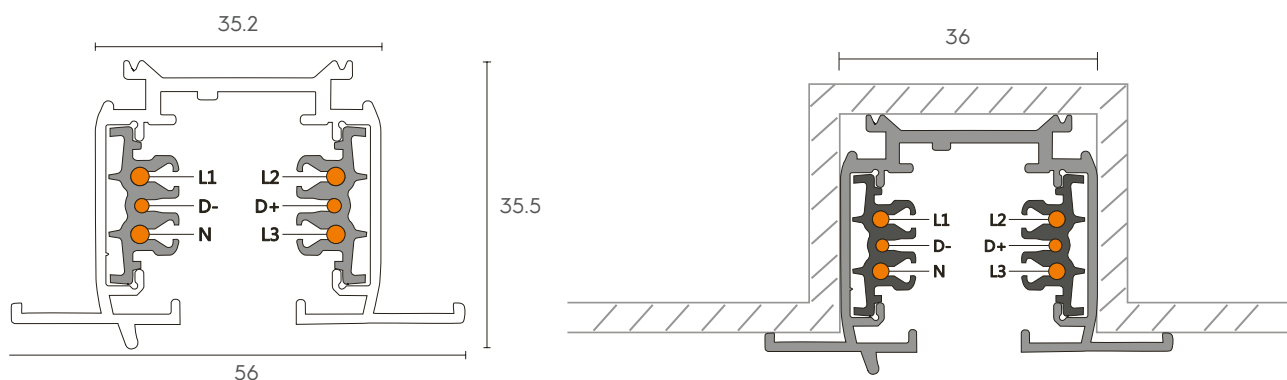

ITEM SPECIFICATIONS

Product description	Colour	Product Code	Package
1 M DALI track (1000mm) recessed	White	20JR03MW0002	1 / 4
1 M DALI track (1000mm) recessed	Grey	20JR03GR0002	1 / 4
1 M DALI track (1000mm) recessed	Black	20JR03BL0002	1 / 4
2 M DALI track (2000mm) recessed	White	20JS03MW0002	1 / 4
2 M DALI track (2000mm) recessed	Grey	20JS03GR0002	1 / 4
2 M DALI track (2000mm) recessed	Black	20JS03BL0002	1 / 4
3 M DALI track (3000mm) recessed	White	20JT03MW0002	1 / 4
3 M DALI track (3000mm) recessed	Grey	20JT03GR0002	1 / 4
3 M DALI track (3000mm) recessed	Black	20JT03BL0002	1 / 4

Connection parts

(Recessed) 3 circuit DALI track system



Connector left DALI 3 circuit

ITEM SPECIFICATIONS

Colour	Product Code	Package
<input type="checkbox"/> White	20JD03MW0002	26 / 130
<input type="checkbox"/> Grey	20JD03GR0002	26 / 130
<input type="checkbox"/> Black	20JD03BL0002	26 / 130

DIMENSIONS

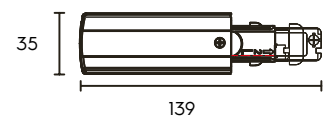

Connector right DALI 3 circuit

ITEM SPECIFICATIONS

Colour	Product Code	Package
<input type="checkbox"/> White	20JE03MW0002	26 / 130
<input type="checkbox"/> Grey	20JE03GR0002	26 / 130
<input type="checkbox"/> Black	20JE03BL0002	26 / 130

DIMENSIONS

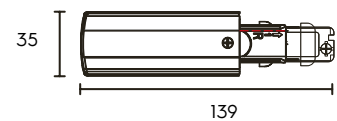

Coupler DALI 3 circuit

ITEM SPECIFICATIONS

Colour	Product Code	Package
<input type="checkbox"/> White	20JF03MW0002	35 / 210
<input type="checkbox"/> Grey	20JF03GR0002	35 / 210
<input type="checkbox"/> Black	20JF03BL0002	35 / 210

DIMENSIONS

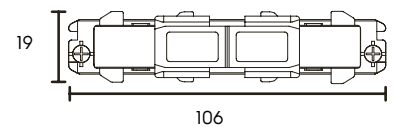

Middle connector DALI 3 circuit

ITEM SPECIFICATIONS

Colour	Product Code	Package
<input type="checkbox"/> White	20JG03MW0002	18 / 108
<input type="checkbox"/> Grey	20JG03GR0002	18 / 108
<input type="checkbox"/> Black	20JG03BL0002	18 / 108

DIMENSIONS

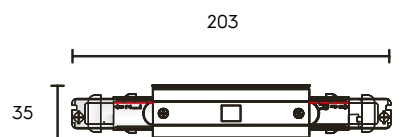



L connector left DALI 3 circuit

ITEM SPECIFICATIONS

Colour	Product Code	Package
<input type="checkbox"/> White	20JH03MW0002	12 / 60
<input type="checkbox"/> Grey	20JH03GR0002	12 / 60
<input type="checkbox"/> Black	20JH03BL0002	12 / 60

DIMENSIONS

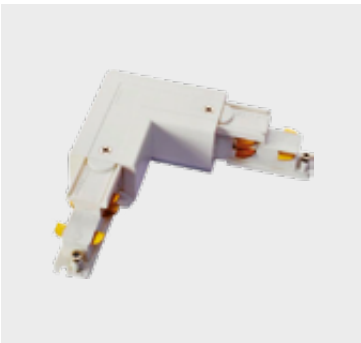
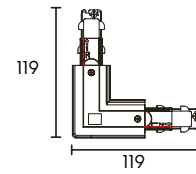

L connector right DALI 3 circuit

ITEM SPECIFICATIONS

Colour	Product Code	Package
<input type="checkbox"/> White	20JJ03MW0002	12 / 60
<input type="checkbox"/> Grey	20JJ03GR0002	12 / 60
<input type="checkbox"/> Black	20JJ03BL0002	12 / 60

DIMENSIONS

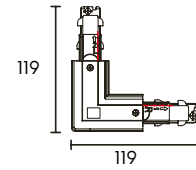

Flexible connector DALI 3 circuit

ITEM SPECIFICATIONS

Colour	Product Code	Package
<input type="checkbox"/> White	20JK03MW0002	12 / 60
<input type="checkbox"/> Grey	20JK03GR0002	12 / 60
<input type="checkbox"/> Black	20JK03BL0002	12 / 60

DIMENSIONS

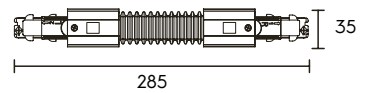

X connector DALI 3 circuit

ITEM SPECIFICATIONS

Colour	Product Code	Package
<input type="checkbox"/> White	20JL03MW0002	2 / 24
<input type="checkbox"/> Grey	20JL03GR0002	2 / 24
<input type="checkbox"/> Black	20JL03BL0002	2 / 24

DIMENSIONS

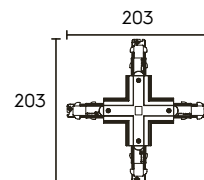





T connector left 1 DALI 3 circuit

ITEM SPECIFICATIONS

Colour	Product Code	Package
<input type="checkbox"/> White	20JN03MW0002	9 / 54
<input type="checkbox"/> Grey	20JN03GR0002	9 / 54
<input type="checkbox"/> Black	20JN03BL0002	9 / 54

DIMENSIONS

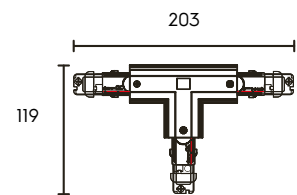

T connector left 2 DALI 3 circuit

ITEM SPECIFICATIONS

Colour	Product Code	Package
<input type="checkbox"/> White	20JP03MW0002	9 / 54
<input type="checkbox"/> Grey	20JP03GR0002	9 / 54
<input type="checkbox"/> Black	20JP03BL0002	9 / 54

DIMENSIONS

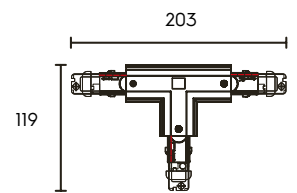

T connector right 1 DALI 3 circuit

ITEM SPECIFICATIONS

Colour	Product Code	Package
<input type="checkbox"/> White	20JQ03MW0002	9 / 54
<input type="checkbox"/> Grey	20JQ03GR0002	9 / 54
<input type="checkbox"/> Black	20JQ03BL0002	9 / 54

DIMENSIONS

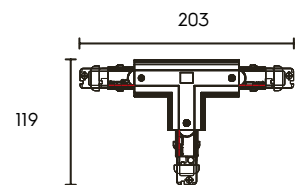

T connector right 2 DALI 3 circuit

ITEM SPECIFICATIONS

Colour	Product Code	Package
<input type="checkbox"/> White	20JM03MW0002	9 / 54
<input type="checkbox"/> Grey	20JM03GR0002	9 / 54
<input type="checkbox"/> Black	20JM03BL0002	9 / 54

DIMENSIONS

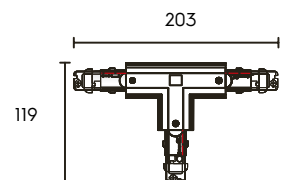

Accessories track system

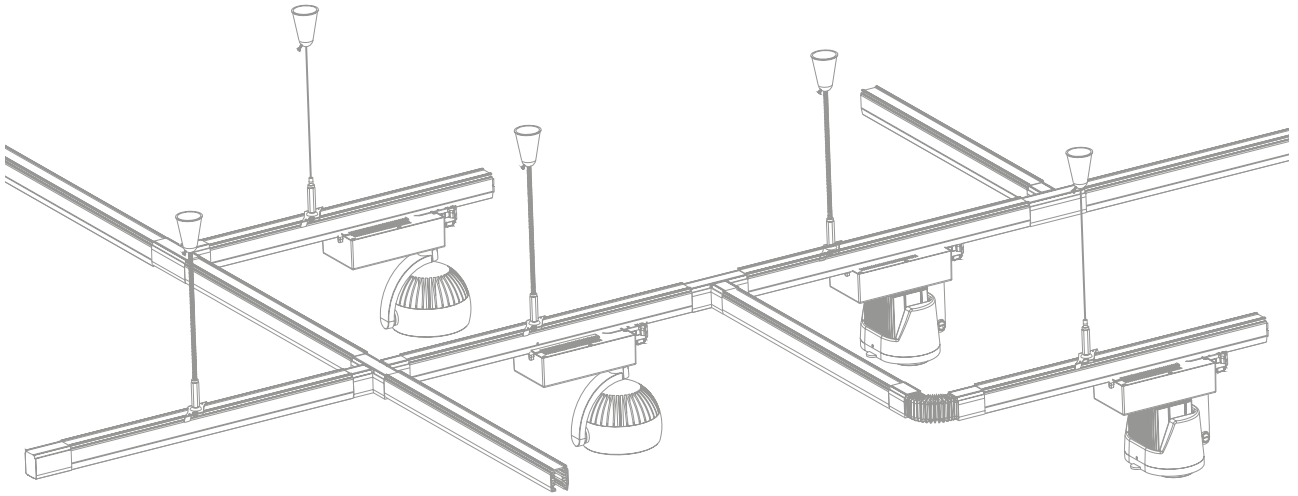

Wire suspension EZCLIK (cable length 5m)

ITEM SPECIFICATIONS

Colour	Product Code	Package
□ White	20HF03MW0002	8 / 96
■ Grey	20HF03GR0002	8 / 96
■ Black	20HF03BL0002	8 / 96

DIMENSIONS

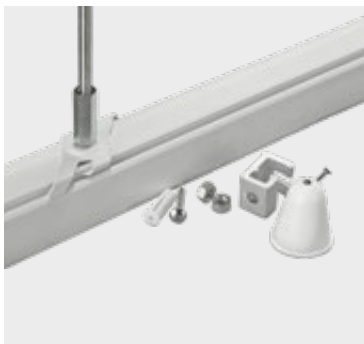
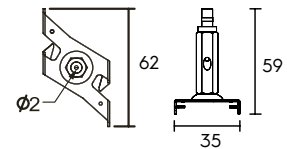

Rod suspension EZCLIK (rod length 1m)

ITEM SPECIFICATIONS

Colour	Product Code	Package
□ White	20HE03MW0002	1 / 30
■ Grey	20HE03GR0002	1 / 30
■ Black	20HE03BL0002	1 / 30

DIMENSIONS

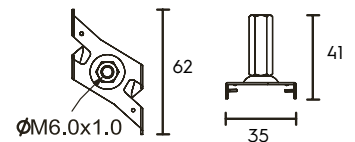

T Bar EZCLIK

ITEM SPECIFICATIONS

Colour	Product Code	Package
□ White	20EZ03MW0002	25 / 500
■ Grey	20EZ03GR0002	25 / 500
■ Black	20EZ03BL0002	25 / 500

DIMENSIONS

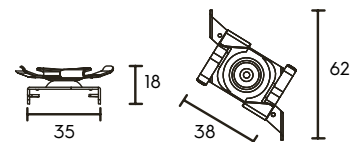



Suspension connection clamp

ITEM SPECIFICATIONS

Colour	Product Code	Package
□ White	20HG03MW0002	6 / 180
■ Grey	20HG03GR0002	6 / 180
■ Black	20HG03BL0002	6 / 180

DIMENSIONS

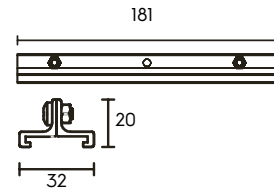

Suspension hook

ITEM SPECIFICATIONS

Colour	Product Code	Package
□ White	20HH03MW0002	20 / 400
■ Grey	20HH03GR0002	20 / 400
■ Black	20HH03BL0002	20 / 400

DIMENSIONS

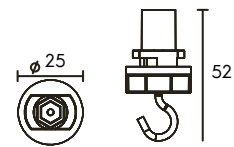

Mechanical adapter

ITEM SPECIFICATIONS

Colour	Product Code	Package
□ White	20HJ03MW0002	6 / 120
■ Grey	20HJ03GR0002	6 / 120
■ Black	20HJ03BL0002	6 / 120

DIMENSIONS

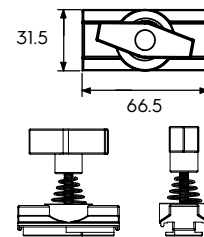

Mounting clamp

ITEM SPECIFICATIONS

Colour	Product Code	Package
□ White	20HK03MW0002	30 / 600
■ Grey	20HK03GR0002	30 / 600
■ Black	20HK03BL0002	30 / 600

DIMENSIONS

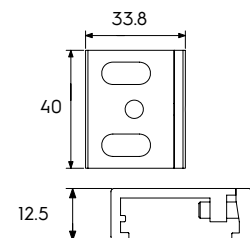

Fixed monopoint for track adapter

ITEM SPECIFICATIONS

Colour	Product Code	Package
□ White	20HL03MW0002	1 / 50
■ Grey	20HL03GR0002	1 / 50
■ Black	20HL03BL0002	1 / 50

DIMENSIONS

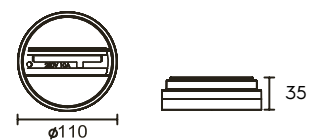



Schuko adapter

ITEM SPECIFICATIONS

Colour	Product Code	Package
White	20HM03MW0002	1 / 50
Black	20HM03BL0002	1 / 50

DIMENSIONS

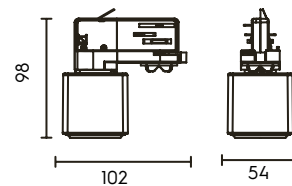

Middle connector cover

ITEM SPECIFICATIONS

Colour	Product Code	Package
White	20HS03MW0002	40 / 480
Grey	20HS03GR0002	40 / 480
Black	20HS03BL0002	40 / 480

DIMENSIONS

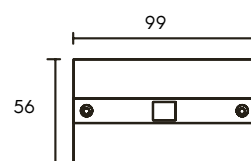

L connector cover

ITEM SPECIFICATIONS

Colour	Product Code	Package
White	20HT03MW0002	25 / 500
Grey	20HT03GR0002	25 / 500
Black	20HT03BL0002	25 / 500

DIMENSIONS

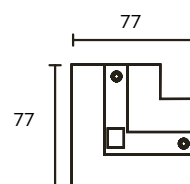

T connector cover

ITEM SPECIFICATIONS

Colour	Product Code	Package
White	20HU03MW0002	30 / 360
Grey	20HU03GR0002	30 / 360
Black	20HU03BL0002	30 / 360

DIMENSIONS

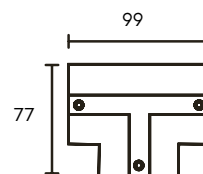

X connector cover

ITEM SPECIFICATIONS

Colour	Product Code	Package
White	20HV03MW0002	80 / 480
Grey	20HV03GR0002	80 / 480
Black	20HV03BL0002	80 / 480

DIMENSIONS

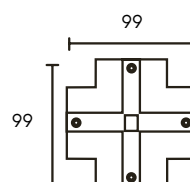



Connector cover (standard)

ITEM SPECIFICATIONS

Colour	Product Code	Package
White	20HR03MW0002	25 / 500
Grey	20HR03GR0002	25 / 500
Black	20HR03BL0002	25 / 500

DIMENSIONS

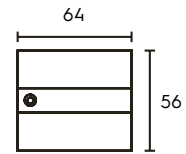

Connector cover (3 circuit DALI)

ITEM SPECIFICATIONS

Colour	Product Code	Package
White	20JU03MW0002	40 / 480
Grey	20JU03GR0002	40 / 480
Black	20JU03BL0002	40 / 480

DIMENSIONS

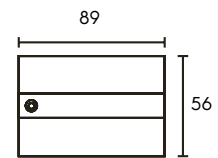

Track system accessories diagram

TRACK SYSTEM ACCESSORIES DIAGRAM - 22

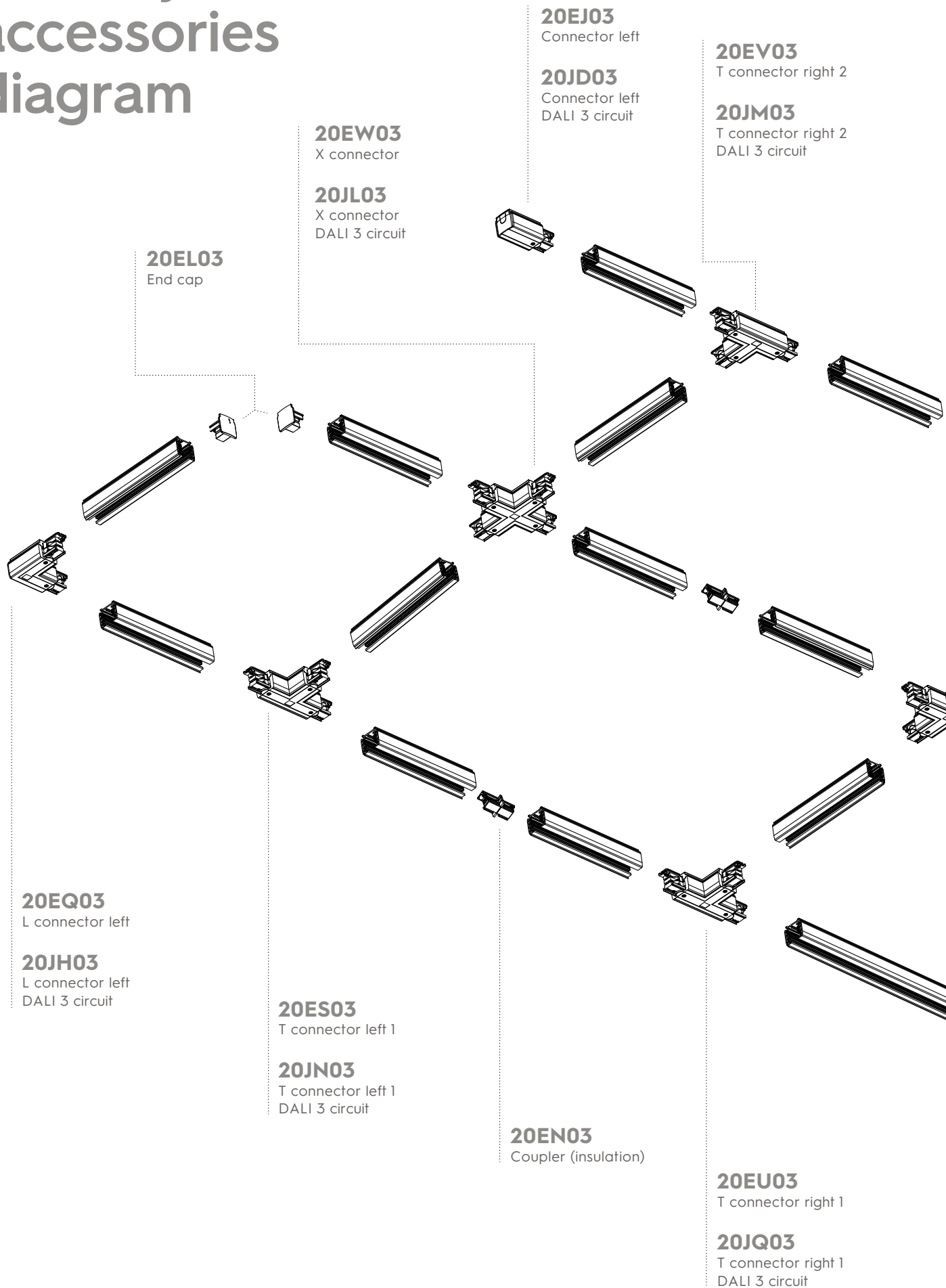

20ET03

T connector left 2

20JP03

T connector left 2
DALI 3 circuit

20EK03

Connector right

20JE03

Connector right
DALI 3 circuit

20EP03

Middle connector

20JG03

Middle connector
DALI 3 circuit

20ER03

L connector right

20JJ03

L connector right
DALI 3 circuit

20EY03

Adjustable connector

20EM03

Coupler

20JF03

Coupler
DALI 3 circuit

20EY03

Adjustable connector

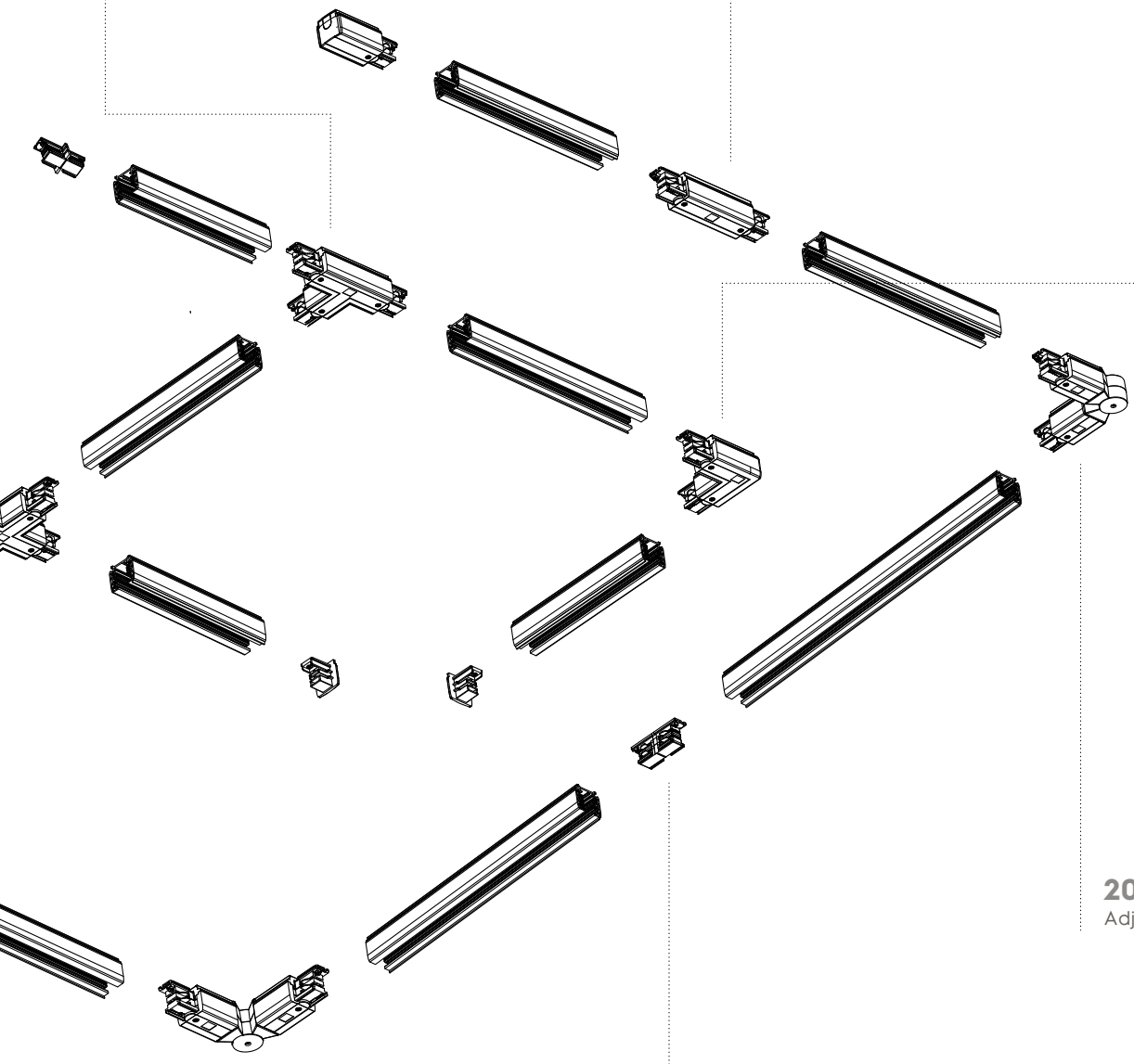



Illuxtron International BV

Mercuriusweg 19
4382 NC Vlissingen
The Netherlands

info@illuxtron.com
+31 (0)85 773 63 60
www.illuxtron.com

ILLUXTRON